



Unlimited Rope Solutions

Dinghy & Custom





LIROS – YOUR EXCELLENT PARTNER



Latest technology *Essential for producing premium products*



Laboratory *Technical development of unique rope solutions*



Quality control *guarantees continuous quality*



Logistics *EDP-based warehousing for fast order processing*





OFFICIAL SUPPLIER

**DEUTSCHER
SEGLER-
VERBAND**



LIROS HSS

||||| Heat Stretch System

LIROS HSS pre-stretch system uses exact heat treatment to guarantee the highest accuracy in any application.

LIROS LCS

||||||| LIROS Coating System

LIROS LCS is the best Protection against wear-and-tear and UV effects for technical ropes. LIROS LCS increases UV- and wear resistance by up to 50%.



*100% recyclable products.
Natural fibres and single-origin
synthetic fibres.*

LIROS line optimization systems

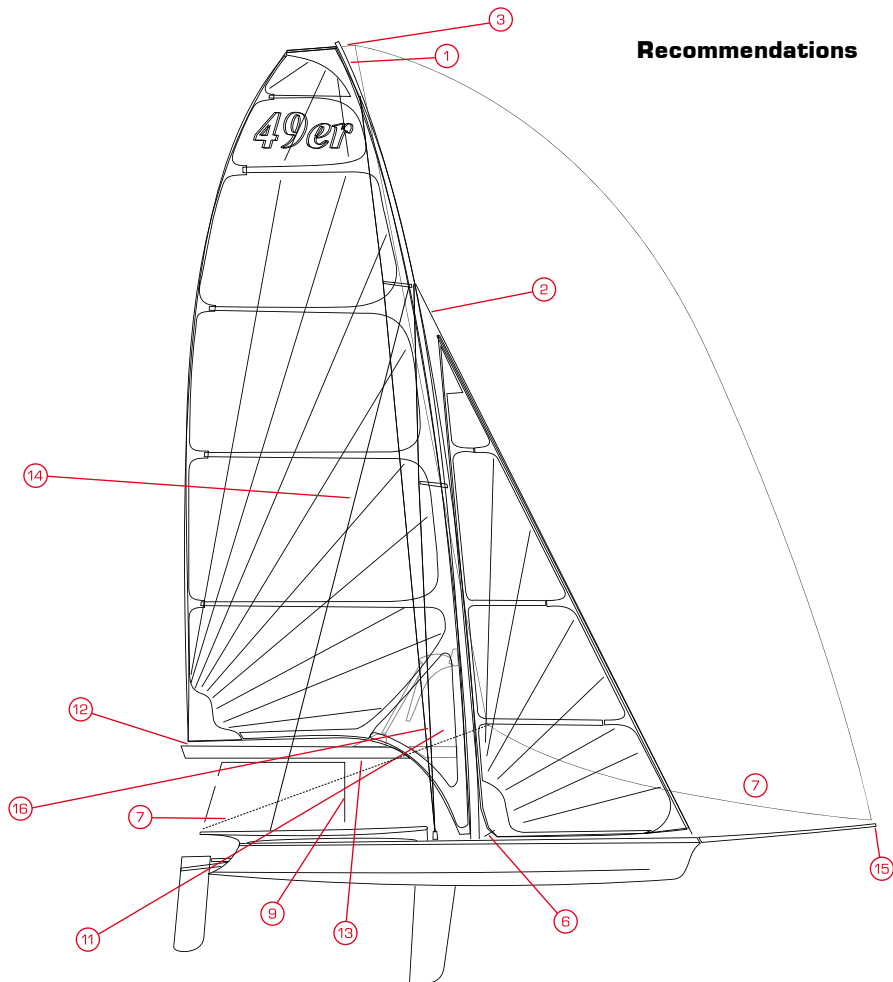

1. Main halyard

LIROS Regatta 2000
LIROS Dynamic
LIROS Magic Race
LIROS Magic Edge
LIROS Magic XTR

2. Jib halyard

LIROS Regatta 2000
LIROS Dynamic
LIROS Magic Race
LIROS Magic Edge
LIROS Magic XTR

**3. Spinnaker/
Gennaker halyard**

LIROS Dynamic
LIROS Magic Race
LIROS Magic Edge
LIROS Magic XTR

4. Pole topping lift

LIROS Dynamic
LIROS Regatta 2000
LIROS Magic Race
LIROS Magic Edge

**5. Pole downhaul/
Kicker**

LIROS Magic Race
LIROS Magic Edge

6. Jib sheet

LIROS Regatta 2000
LIROS Magic Flow
LIROS Magic Race
LIROS Magic Pro
LIROS Magic Sheet
LIROS Magic Sport

**7. Spinnaker/
Gennaker sheet**

LIROS Magic Flow
LIROS Dynamic
LIROS Magic Control-XTR
LIROS Magic Edge
LIROS Dynasoft
LIROS Spi
LIROS Nautic

8. Guy / Brace

LIROS Dynamic
LIROS Magic Control-XTR
LIROS Magic Edge
LIROS Regatta 2000

9. Main sheet

LIROS Magic Flow
LIROS Racer
LIROS Dynamic
LIROS Magic Pro
LIROS Dynasoft

**10. Backstay/
Running backstay**

LIROS Regatta 2000
LIROS Magic Edge
LIROS D-Pro

11. Cunningham

LIROS Racer
LIROS Regatta 2000
LIROS D-Pro
LIROS Magic Race
LIROS Magic Edge
LIROS Magic Sport

12. Outhaul

LIROS Regatta 2000
LIROS D-Pro
LIROS Magic Edge
LIROS Magic Race

**13. Boomvang/
Vang kicker**

LIROS Racer
LIROS Dynamic
LIROS D-Pro
LIROS Magic Pro

14. Trapeze Lines

LIROS D-Pro
LIROS D-Pro XTR
LIROS V-Force
LIROS Magic Surf

15. Tackline

LIROS Racer
LIROS Dynamic
LIROS D-Pro
LIROS Magic Pro
LIROS Magic Edge
LIROS Magic Control-XTR

16. Downhaul

LIROS Racer
LIROS Dynamic
LIROS D-Pro
LIROS Magic Pro



LIROS Magic XTR

01513

LIROS Magic XTR is ideal for use in dinghies and multihulls. Superior high grip, extremely durable cover. Perfect in cleats. The professional's choice.

- working stretch < 1 %
- removable cover for top performance
- superior abrasion resistance – combo-cover (twisted Technora®/Dyneema®)
- best cover-core attachment
- very low stretch, highest breaking load
- LIROS Heat-Stretch-System

Ø mm	Breaking strength kg	Length of spool m
4	620	100
5	1400	100
6	1800	100



Colours



231
White-Yellow



239
White-Black

Cover

Technora®/Dyneema® Mix

Construction

4 – 5 mm 16-plaited
6 mm 24-plaited

Core

Dyneema® SK78 with
LIROS XTR Grip Coating



LIROS Magic Control XTR

02024

Maximum grip for exact control of your dinghy. High tech materials provide highest reliability and enable precise manoeuvres, when it counts.

- working stretch < 1,0%
- coated core
- very resistant and handy
- minimum stretch
- LIROS Heat-Stretch-System

Ø mm	Breaking strength kg	Length of spool m
4	1100	100
5	1450	100
6	2800	100



Colours



090
Green-Black



178
Red-Black



239
White-Black



652
Neon Yellow-Black

Cover

Technora®/Polyester

Construction

4 – 5 mm 16-plaited
6 mm 24-plaited

Core

Dyneema® SK78 silver with
LIROS XTR Grip Coating



LIROS Magic Pro

01507

LIROS Magic Pro combines all of the best characteristics with extreme low stretch. Outstanding block performance, enabling ultra-fast manoeuvres. The core is coated and specially treated with LIROS Heat-Stretch-System. The cover is made of a special Polyester grip fibre / spun-dyed Polyester mix for optimal control and perfect handling in manoeuvres.

- working stretch < 1,5%
- precise cover construction for excellent hold in cleats and winches
- ideal for cover-stripping
- LIROS Heat-Stretch-System for lowest stretch

Ø mm	Breaking strength kg	Length of spool m
3	450	100
4	620	100
5	1250	100
6	1800	100
8	3000	100

Colours



Cover
Polyester grip fibre / spun-dyed Polyester mix

Construction
16-plaited

Core
Dyneema® SK78 with coloured LIROS XTR grip coating



LIROS Magic Edge

01502

Robust and handy low-stretch performance rope for all applications to regatta and advanced dinghy sailing boats. Best abrasion resistance due to high tech and tight cover braid.

- working stretch < 1,0%
- coated core
- resistant and handy construction
- low elongation
- 1,5-2mm single-coloured
- LIROS Heat-Stretch-System

Ø mm	Breaking strength kg	Length of spool m
1,5	125	100
2	250	100
3	420	100
4	580	100
5	1050	100
6	1800	100
7	2300	100

Colours



Cover
Spun dyed Polyester

Construction
1,5-5 mm 16-plaited
6mm and up 1:1 plaited

Core
Dyneema® SK78 silver with LIROS XTR grip coating





LIROS Magic Race

02016

Extremely low stretch, compact and abrasion resistant braid with high-strength Dyneema® core.

- working stretch < 1,5%
- highly UV resistant
- low stretch
- high grip

Ø mm	Breaking strength kg	Length of spool m
2	270	100
2,5	390	100
3	550	100
4	800	100
5	1100	100

Colours



010
Blue



086
Green



123
Neon Yellow



171
Red



188
Black



228
White



Cover

special high-twisted Polyester

Construction

2–3 mm 16-plaited
4 mm and up 1:1 plaited

Core

Dyneema® SK78 coated

LIROS DynaSoft

02055

LIROS DynaSoft combines the best grip, the lightest weight, and the lowest stretch. Combination braid of high-strength Polyester grip fibres and Dyneema®. Ideal for dinghy sheets and regatta halyard leads.

- working stretch < 2%
- high grip
- extremely flexible
- excellent handleability
- limited suitability on winches
- LIROS Heat-Stretch-System for lowest stretch

Ø mm	Breaking strength kg	Length of spool m
7	1200	100
9	2000	100



Colours



081
Grey-Green



386
Grey-Red



504
Grey-Turquoise

Material

Ideal hybrid of Dyneema® SK78 and Polyester grip fibres

Construction

8-plaited with core



LIROS Magic Sport

01517

Technical high-grade, universally useable line in striking Neon-Design for dinghies and small keel boats. Very abrasion resistant core in cleats, low stretch due to heat-set Polyester core.

- working stretch < 5%
- very abrasion resistant
- high visibility
- low stretch



Ø mm	Breaking strength kg	Length of spool m
2	95	100
3	185	100
4	550	100
5	850	100
6	1000	100

Colours



781
Neon Yellow-White



417
Neon Yellow-Pink



771
Neon Yellow-Silver



773
Neon Yellow-Blue

Cover

spun dyed Polyester

Construction

16-plaited

Core

high-strength Polyester

LIROS Magic Sheet

01506

LIROS Magic Sheet has been specially developed for use as main and jib sheets on dinghies, sports boats, and catamarans. Polyester grip fibres provide best cover-core attachment and perfect grip for optimal control in any situation.

- working stretch < 8%
- great in turning blocks, fastest manoeuvres
- very compact non splice construction
- best handling and non-kinking characteristics

Ø mm	Breaking strength kg	Length of spool m
7	970	100
9	1500	100



Colours



404
White-Silver



406
White-Orange



405
White-Navy



428
White-Pink

Cover

Polyester grip fibre /
spun-dyed Polyester mix

Construction

16-plaited

Core

Polypropylene high-strength plaited

NEW



LIROS Magic Flow

01510

LIROS Magic Flow represents the perfect compromise between stiffness and flexibility. Maximum stiffness to minimize knot formation but still sufficiently smooth to roll through the blocks without any problems. Developed in collaboration with Philipp Buhl from German Sailing Team.

- working stretch < 7%
- minimal knot formation
- resistant and handy construction
- LIROS Heat-Stretch-System

Ø mm	Breaking strength kg	Length of spool m
------	----------------------	-------------------

6	690	100
---	-----	-----

Cover
Polyester

Construction
16-plaited

Core
high-tenacity Polypropylene

Colour



298
Silver-Neon Orange

LIROS HSS
LIROS Heat-Stretch-System



Philipp Buhl



© Jack Fletcher / Down Under Sail

The Magic Flow is my favorite ILCA-main sheet yet!



DINGHY PERFORMANCE

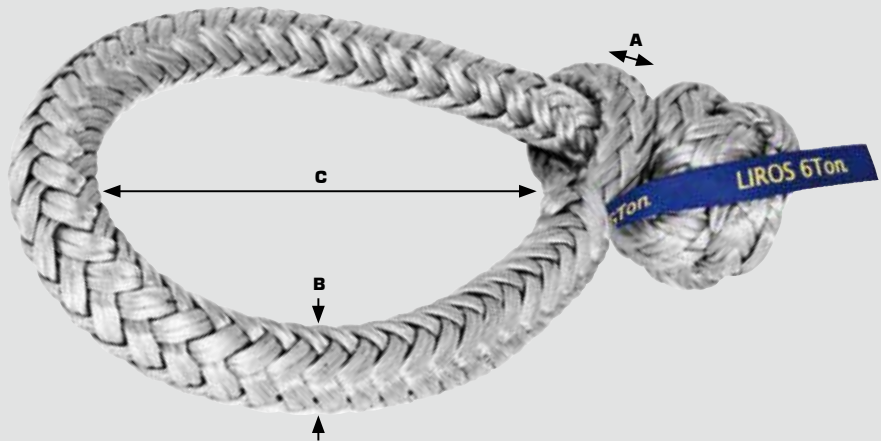

LIROS Soft Shackle

Fastening sheets, shackle halyards, fix blocks – the LIROS XTR Soft Shackle is the solution! 100% made of high-strength fiber Dyneema® SK7B, replaces heavy metal shackles on deck. Easy and fast opening, thanks to the blue „LIROS ribbon“ with breaking strength information.

- no damages on deck or risk of injuries when operating by flapping metal parts
- suitable for many applications in sectors industry, offroad and outdoor
- 10x lighter than steel shackles at same breaking strength
- easy and intuitive handling
- self-locking construction under load
- easy to open after use with high loads
- safety factor 2: 1



Material Dyneema® SK7B

Colours

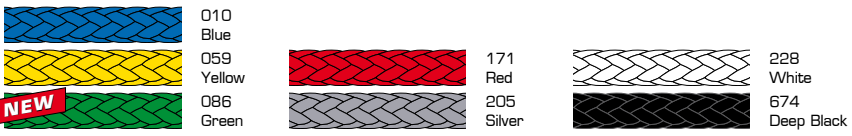

Reference	Breaking strength t	Colour	SWL ** t	A Material Ø mm	B Final Ø app. mm	C Inner length mm
00146-0066	1	228 White*	0,5	4	6	65
00146-0090	1,5	674 Deep Black	0,75	5	9	90
00146-0069	2	171 Red*	1	6	12	120
00146-0070	4	010 Blue*	2	8	13	135
00146-0071	6	059 Yellow*	3	9	15	150
00146-0072	8	086 Green	4	10	19	150
00146-0073	10	674 Deep Black	5	12	20	190

* All sizes also available in deep black or silver!

** SWL = Safe Work Load



Not certified for lifting loads and personal security!



LIROS Spisheet Pro

02049-0000

Very light, high quality, individually produced tapered LIROS spinnaker sheet with Dyneema® SK78 core for extremely low stretch and high strength. Minimal water absorption.

- individual LIROS customisation available for any boat
- length, diameter, and colour customised to your specifications
- tailor-made for long working life
- lowest stretch and water absorbency
- premium spun Polyester for optimal grip
- available in diameters from 3 – 12 mm
- lowest weight
- available with eye splice



Cover

thick end – high-grip matt Polyester with Dyneema® SK 78 / tapered end – 100% Dyneema® SK 78

Core

braided Dyneema® SK 78

Also available as

Opti-Design

6-9-6 mm in length of
1,5 - 2,5 - 3 m = 7 m total length

Reference: 02042-0100

more info at www.liros.com

Colours



021
Blue-White
067
Yellow-White



092
Green-White
179
Red-White

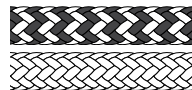

204
Black-White
542
White NF

Required order specifications:

1. Ø thick end
2. length thick end
3. Ø tapered end
4. length tapered end
5. colour

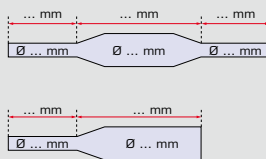

Available Ø 02049 [mm] / Breaking strength tapered end [kg]:

5 – 3 / 480	10 – 4 / 780	8 – 6 / 2000
6 – 3 / 480	8 – 5 / 950	9 – 6 / 2000
6 – 4 / 780	9 – 5 / 950	10 – 6 / 2000
8 – 4 / 780	10 – 5 / 950	12 – 6 / 2000
9 – 4 / 780	12 – 5 / 950	12 – 8 / 3000



LIROS Spi

02049

Very lightweight and high quality LIROS spinnaker sheet with Dyneema® SK78 core for optimal grip, low stretch and high strength. Minimal water absorption.

- working stretch < 3%
- premium spun Polyester for optimal grip
- lowest stretch
- light weight



BIO-BASED DYNEEMA®

Colours



092
Green-White
179
Red-White



542
White NF

Ø mm	Breaking strength kg	Length of spool m
5	650	100
6	800	100
8	1000	100
10	1900	100

Cover

high-grip matt Polyester with Dyneema® SK 78

Core

Dyneema® SK 78 plaited

CUSTOM PERFORMANCE

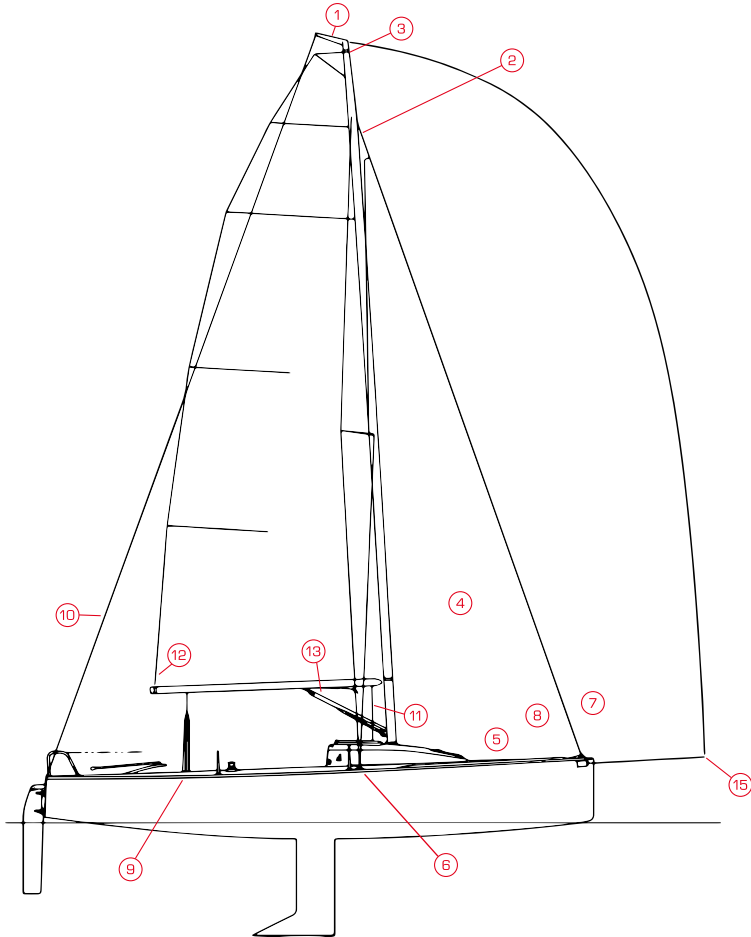

1. Main halyard

LIROS Racer Hybrid
LIROS Racer Vision
LIROS Racer
LIROS Regatta 2000
LIROS Magic XTR
LIROS D-Pro XTR

2. Jib halyard

LIROS Racer
LIROS Racer Hybrid
LIROS Racer Vision
LIROS Regatta 2000
LIROS Magic XTR
LIROS D-Pro XTR

3. Spinnaker halyard

LIROS Racer Hybrid
LIROS Racer
LIROS Dynamic
LIROS Magic Control XTR
LIROS Magic Edge

4. Pole topping lift

LIROS Racer Hybrid
LIROS Dynamic
LIROS Regatta 2000

5. Pole downhaul

LIROS Racer Hybrid
LIROS Racer
LIROS Magic Control XTR

6. Genoa sheet

LIROS Racer Hybrid
LIROS Racer
LIROS Regatta 2000
LIROS Magic Control-XTR

7. Spinnaker sheet

LIROS Racer
LIROS Dynamic
LIROS Magic Control-XTR
LIROS Magic Edge
LIROS Dynasoft
LIROS Spi

8. Guy/Brace

LIROS Racer
LIROS Racer Vision
LIROS Dynamic
LIROS Regatta 2000

9. Main sheet

LIROS Racer
LIROS Racer Hybrid
LIROS Dynamic
LIROS Magic Pro
LIROS Magic XTR

**10. Backstay/
running backstay**

LIROS V-Force
LIROS Regatta 2000
LIROS D-Pro XTR

11. Cunningham

LIROS Racer
LIROS Regatta 2000
LIROS D-Pro
LIROS Magic Edge

12. Outhaul

LIROS V-Force
LIROS Regatta 2000
LIROS D-Pro
LIROS Magic Edge

13. Boomvang

LIROS Racer
LIROS Dynamic
LIROS D-Pro XTR
LIROS Magic Pro

14. Boom topping lift

LIROS Dynamic

15. Tackline

LIROS Magic Control XTR
LIROS Magic Edge



LIROS D-Pro-XTR

01514

D-Pro-XTR is a 12-plaited braided Dyneema® line with highly durable XTR Grip Coating. Well-suited as a replacement for steel ropes and hard shackles. D-Pro-XTR is the ultimate line for applications that require the least stretch.

- XTReme high breaking load
- grip factor 3
- extremely low stretch
- very light weight
- easy to splice
- no water absorption
- easy to cover with Protect-XTR

Ø mm	Weight g/m	Stretch %	Breaking strength kg
2,5	3,5	< 1,0	700
3	5	< 1,0	1150
4	7	< 1,0	1500
5	13	< 1,0	3200
6	23	< 1,0	5600
8	35	< 1,0	7000
10	60	< 1,0	11000
12	72	< 1,0	15000
14	95	< 1,0	18000
16	131	< 1,0	22400
18	166	< 1,0	28000



LIROS HSS
Heat Stretch System
LIROS LCS
LIROS LCP Coating System

Colour

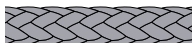

205
Silver

Material Dyneema® SK99
Construction 12-plaited



LIROS Racer-Hybrid

02026

LIROS Racer-Hybrid offers an exceptional combination of heat- and cut-resistant hybrid fibres and high-tenacity Polyester. The cover can be stripped with ease for weight reduction. LIROS Racer-Hybrid has a perfectly balanced cover-core ratio for maximum reliability and best breaking strength.

- working stretch < 1,5 %
- excellent abrasion resistance, even at high temperatures
- perfect for extreme performance with stripped cover
- lightweight
- ideal interconnected cover-core
- multipurpose sheet and halyard rope
- LIROS Heat Stretch System

Ø mm	Breaking strength kg	Weight g/m	Length of spool m
6	2900	25	200
8	4200	48	200
10	5500	65	200
12	8000	93	200
14	10500	121	150



Vectran®

LIROS HSS
Heat Stretch System
LIROS LCS
LIROS LCP Coating System

Cover 50% Vectran® / 50% Polyester
Core Dyneema® XTR-Grip-Coating Silver
Construction 6 mm 16-plaited
8 mm 24-plaited
10mm and up 32-plaited

Colours



419
Beige-Orange
421
Beige-Yellow
263
Beige-Steelblue



422
Beige-Burgundy
262
Beige-Silver



549
Beige-Black

DINGHY HIGH PERFORMANCE



LIROS Racer Vision

02027

New high-tech rope in a modern style. Simple stripping and easy to splice. Excellent retention forces on winches and rope stoppers. Perfect design with special abrasion resistant LIROS steelblue Polyester. Special XTR-Grip-Coating.

- working stretch < 1,5%
- maximum breakload and low weight
- ideal for halyards, sheets and winch uses
- easy to splice
- LIROS Heat-Stretch-System

Colours

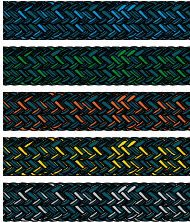

- 212 Steelblue-Blue
- 353 Steelblue-Green
- 704 Steelblue-Orange
- 707 Steelblue-Neon Yellow
- 774 Steelblue-Silver

Ø mm	Breaking strength kg	Weight g/m	Length of spool m
8	4200	53	200
10	5500	75	200
12	8000	96	200
14	10500	127	150

Cover	Polyester high twisted	
Construction	8 mm	24-plaited
	10 mm and up	32-plaited
Core	Dyneema® with XTR-Grip-Coating	



LIROS V-Force

04000

LIROS V-Force with high strength Vectran® fibre. Super low stretch, comparable to wire, extremely durable and abrasion resistant. Excellent holding strength in stoppers and cleats with specialised 32-plait cover, ideal for halyards and back-stays.

- working stretch < 1%
- very low initial stretch
- ideal interconnected cover-core
- best stopper durability
- no creep

Colours

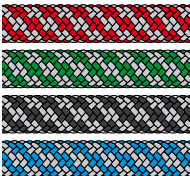

- 423 Silver-Red
- 424 Silver-Green
- 445 Silver-Black
- 593 Silver-Blue

Ø mm	Breaking strength kg	Weight g/m	Length of spool m
5	950	17	250
6	1400	24	200
8	2800	56	200
10	3700	80	200
12	5300	105	200

Cover	Polyester high-twisted	
Construction	3 – 5 mm	16-plaited
	6 – 8 mm	24-plaited
	10 mm and up	32-plaited
Core	Vectran®, 8 mm and up with additional cover plait	





LIROS Regatta 2000

02000

Very low-stretch line for halyards, spinnaker and genoa sheets. An extremely light and durable high-performance rope with abrasion resistant braided cover and inner cover. Specialised core of coated Dyneema® SK 78.

- working stretch < 1,5%
- extreme break resistant, light and durable
- 30% more abrasion resistant than conventional Polyester
- LIROS Heat-Stretch-System

Cover Special Polyester high-twisted
Construction 2–3 mm 16-plaited
 4 mm and up 1:1 plaited
Core Coated Dyneema® SK 78,
 8 mm and up with additional cover plait

Ø mm	Breaking strength kg	Weight g/m	Length of spool m
2	270	3	250
2,5	390	5	250
3	550	7	250
4	800	11	250
5	1100	15	250
6	2500	25	200
8	3800	42	200
10	5000	61	200
12	7200	88	200
14	9500	132	150
16	12600	150	100
18	15300	180	100
20	18500	236	100
22	20000	282	100
24	23000	321	100

Colours

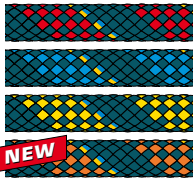

354 Steel-blue-Red
 212 Steel-blue-Blue
 352 Steel-blue-Yellow
 952 Steel-blue-Neon Orange

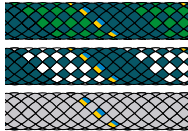

353 Steel-blue-Green
 213 Steel-blue-White
 205 Silver

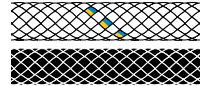

228 White
 525 Black NF



LIROS Racer

02001

Proven, durable Dyneema® rope with high breaking load and low stretch featuring a specially-engineered 32-plaited cover and coated Dyneema® SK78 fibre core. For halyards and sheets. Very suitable for winches.

- working stretch < 1,5%
- high breaking load, easy handling and non-kinking
- very good winch suitability
- LIROS Heat-Stretch-System



Ø mm	Breaking strength kg	Weight g/m	Length of spool m
6	2500	27	200
8	3800	51	200
10	5000	71	200
12	7200	85	200
14	9500	115	150
16	12600	144	100
18	15300	179	100

Colours

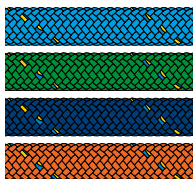

010 Blue
 086 Green
 130 Marine
 150 Orange

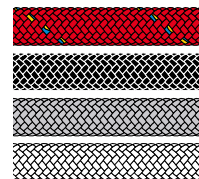

171 Red
 525 Black NF
 529 Silver NF
 542 White NF

Cover

Polyester high twisted

Construction

6–8 mm 24-plaited
 10 mm and up 32-plaited

Core

Coated Dyneema® SK78 with additional cover plait



LIROS Dynamic Color

02028

Easy-handling, abrasion resistant line with low stretch, premium Polyester cover and Dyneema® SK78 core. Suitable for use as a highend sheet, or low-stretch halyard by advanced cruising sailors.

- working stretch < 2%
- kink-free, low-stretch sheets for cruiser-racers
- easy to splice
- LIROS Heat-Stretch-System



LIROS HSS

LIROS LCS

LIROS LCS

Ø mm	Breaking strength kg	Weight g/m	Length of spool m
3	500	7	250
4	710	11	250
5	870	17	250
6	1200	21	200
8	2300	38	200
10	3100	69	200
12	4800	89	200
14	6500	119	150

Colours

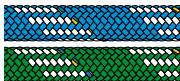

021
Blue-White
092
Green-White



067
Yellow-White
179
Red-White



775
Dark Grey-White

Cover

Polyester high twisted

Construction

3–5 mm 16-plaited
6–8 mm 24-plaited
10 mm and up 32-plaited

Core

Dyneema® coated, 6 mm and up with additional cover plait

LIROS Dynamic Plus

02004

Easy-handling, abrasion resistant line with low stretch, premium Polyester cover and Dyneema® SK78 core. Suitable for use as a highend sheet, or low-stretch halyard by advanced cruising sailors.

- working stretch < 2%
- kink-free, low-stretch sheets for cruiser-racers
- easy to splice
- LIROS Heat-Stretch-System



LIROS HSS

LIROS LCS

LIROS LCS

Ø mm	Breaking strength kg	Weight g/m	Length of spool m
3	500	7	250
4	710	11	250
5	870	17	250
6	1200	21	200
8	2300	38	200
10	3100	69	200
12	4800	89	200
14	6500	119	150

Colours

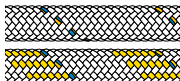

228
White
231
White-Yellow

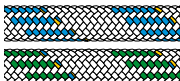

229
White-Blue
232
White-Green



236
White-Red

Cover

Polyester high twisted

Construction

3–5 mm 16-plaited
6–8 mm 24-plaited
10 mm and up 32-plaited

Core

Dyneema® coated, 6 mm and up with additional cover plait



LIROS D-Pro

01505

LIROS Heat-Stretch-System guarantees optimal breaking loads and stretch characteristics of this line. Excellent chafing resistance, light weight, and easy spliceability make this line irreplaceable in all sorts of applications on racing boats of any size. Perfect as a replacement for steel cabling in technical applications.

- working stretch < 1 %
- very high breaking load with small diameter and very low weight
- first choice for any application under extreme loads
- very spliceable
- highly UV stable and chafe resistant
- LIROS Heat-Stretch-System

Material Coated Dyneema® SK78

Construction 12-plaited, heat-set and coated

Ø mm	Breaking strength kg	Weight g/m	Length of spool m
1	195	0,9	100
1,5	230	1,3	100
2	410	1,8	100
2,5	580	3,5	100
3	950	4,6	100
4	1300	7	100
5	2600	13	100
6	4300	23	100
8	5300	35	100
9	7500	49	100
10	9000	60	100



Not certified for lifting loads and personal security!

Colours



010
Blue
059
Yellow
086
Green

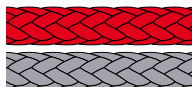

171
Red
205
Silver



228
White
674
Deep Black (2 and up)



LIROS D-Pro Vision

01508

The new LIROS D-Pro Vision made of 100% Dyneema® SK78 with extremely high breaking loads at lowest weight! Best differentiation in all applications – whether as high-strength winch rope in industrial use or as universally useable watersports line. High UV-stability combined with best abrasion resistance and highest breaking loads at lowest weight guarantee best safety in practical use. First choice for replacing steel ropes in sports and industrial use.

- working stretch < 1 %
- very spliceable
- highly UV stable and chafe resistant
- LIROS-Heat-Stretch-System

Material
Coated Dyneema® SK78

Construction
12-plaited, heat-set and coated



Ø mm	Breaking strength kg	Weight g/m	Length of spool m
3	950	4,6	100
4	1300	7	100
5	2600	13	100
6	4300	23	100
8	5300	35	100
10	9000	60	100

Colours



019
Blue-Black



065
Yellow-Black



178
Red-Black



LIROS Shock Cord

00190

Our high-elasticity shock cord with the best in stretch characteristics. Braided out of abrasion resistant Polyester in solid colour or white with blue-gold mark yarn.

- round, abrasion-resistant construction
- also available in industrial bulk quantities
- Made in Germany

Ø mm	Breaking strength cover kg	Length of spool m
3	40	100
4	100	100
5	100	100
6	180	100
7	300	100
8	350	100
10	350	100
12	410	100
14	480	100

Colours

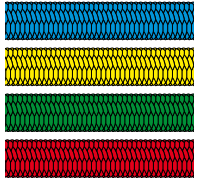

- 010 Blue
- 059 Yellow
- 086 Green
- 171 Red

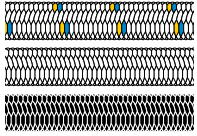

- 228 White
- 542 White NF
- 188 Black

Cover
Polyester

Construction
3 – 8 mm 16-plaited
10 – 14 mm 24-plaited

Core
premium Latex

LIROS Stretch XTR

00199

High quality Shock Cord with extremely abrasion resistant 100% Dyneema® jacket. Intelligent cover construction design with maximum breakload.

- highest abrasion resistance
- very lightweight
- low water absorption
- UV-resistant

Ø mm	Breaking strength cover daN	Length of spool m
3	150	100
4	290	100
5	300	100
6	320	100

Colour



- 239 White-Black



Cover
Dyneema®

Construction
16-plaited

Core
high quality Latex rubber



LIROS Nautic

01072

Soft, very light, and easy-to-handle spiseet for dinghies or small keelboats. Can also be used as water-ski rope or towline. Spun-dyed, multi-purpose floating line. Round-woven, UV-stabilised, durable Polypropylene multifilament. **1 – 5 mm without flecks.** 6 – 16 mm with flecks in blue/gold.

- working stretch < 12%
- very lightweight
- easy to handle
- floatable
- UV-stabilised



Colours Ø 1-5 mm (NF)

	525 Black
	526 Blue
	527 Green
	530 Red
	536 Yellow
	539 Orange
	541 Grey
	543 Brown

Colours Ø 6-16 mm

	010 Blue
	059 Yellow
	086 Green
	150 Orange
	171 Red
	188 Black
	541 Grey NF
	543 Brown NF

Ø mm	Breaking strength kg	Length of spool m
1	30	500
1,5	38	500
2	70	500
3	140	500
4	280	500
5	390	250
6	550	200
8	900	200
10	1230	200
12	1700	200
14	2000	150
16	3700	100

Material

Polypropylene multifilament

Construction

8-plaited

LIROS Magic Surf

The LIROS Magic Surf is specially designed for wind surfing and enables exact setting of the sail tension. 03000-0380 is suitable for all kinds of clutches.

00148-0419 enables extreme grip on sensitive clutches and at higher stress on systems with ratchet.

- working stretch < 1%
- extremely low stretch

Colour

	228 White
--	--------------

Reference	Ø mm	Breaking strength kg	Length of spool m
03000-0380	3,8	1000	100
00148-0419	4,2	800	100

Material

Dyneema® SK 78, pre-stretched

Konstruktion

3,8 mm 16-plaited
4,2 mm 8-plaited





LIROS Whipping Twine / Sewing Thread

Reference	Ø mm	Number of spools / length	Construction	Treatment	Colour
00001	1,0	5 x 30m	plaited	unwaxed	292 White assorted
	1,5	5 x 20m	plaited	unwaxed	292 White assorted
	1,5	5 x 20m	plaited	heavy waxed	292 White assorted
	1,2	5 x 30m	twisted	waxed	292 White assorted
00006	0,5	20 x 80m	twisted	waxed	072 White
00007	1,2	20 x 30m	twisted	waxed	072 White
00008	1,5	20 x 20m	plaited	heavy waxed	072 White
00011	1,0	20 x 30m	plaited	heavy waxed	072 White
00012	1,5	20 x 20m	plaited	unwaxed	054 assorted colours*
00013	1,5	20 x 20m	plaited	heavy waxed	293 assorted colours*
Sewing Thread 00099-0400	0,3	10 x 140m	Polyester		228 White

All whipping twine also available in bulk 500m spools.

*assorted colours: Black, Blue, Green, Red, Yellow

LIROS Dyneema® Waxed Whipping Twine

00016	0,5	20x60m	braided	waxed	529 Silver
00017	1,2	20x30m	braided	waxed	529 Silver

NEW



LIROS Whipping twine set

01042-0122

LIROS waxed whipping twine in 1,2mm and a LIROS 00143-4001 micro splicing needle.

- waxed whipping twine white
- micro splicing needle

Ø mm	Length of spool m
1,2	100

Material
Polyester

Construction
twisted



SELECTIONS IN SHOW-BOXES



LIROS Optisail

02056

Low-stretch Opti lanyards for longlasting use and great knot holding.

- working stretch < 1,5%
- best knot holding
- extremely, strong and pliable

Ø mm	Number of spools / length
---------	------------------------------

1,2

20 x 20 m

Colour



199
Black-Red



BIO-BASED DYNEEMA®

Cover
Polyester

Construction
16-plaited with core

Core
Dyneema® SK7B



NEW



LIROS Heat Cutter Cordless 00146

- 115W rating
- ideal for mobile use
- quick setup and cutting edge heating
- 00146-0284 Heat Cutter Pro
- 00146-0001 Replacement blade



TECHNICAL ACCESSORIES



LIROS XTR-Finish 00146-0057

LIROS XTR-Finish is the perfect coating for additional protection against abrasion and UV effects on all kind of ropes (Polyester, Dyneema®, Zylon®). LIROS XTR-Finish comes in 250ml bottles.

- ready to use
- optimized UV-protection
- easy-to-clean, water-based solution
- each package: 250ml bottle + sponge
- available colours: 010 Blue, 059 Yellow, 078 Grey, 086 Green, 171 Red, 220 Transparent





LIROS Rigger Bag

00146-0056

Premium splicing kit for the professional sailor. Contains all the splicing tools and accessories needed to work on all known LIROS yachting rope types.

- ext. dimensions: 41x31x10cm
- Contains: 1x Whipping needle; 1x swedish fid; 3x splicing needles (5,5–7,5–10mm); LIROS rope catalogue; 1x scissor; LIROS USB-Stick with splicing instructions; LIROS Tape; Dyneema® whipping twine; 1x pen; 1x lighter



LIROS Splicing Needle Set 00143

Five premium stainless steel splicing needles, perfect for splicing ropes from 4–14mm in diameter. Suitable for twisted and for plaited lines. Comes in a convenient plastic tube with screw-top.

- Measurements: 233 x 12,5mm; 175 x 9mm; 115 x 7mm; 135 x 5mm

Reference	Size	Content	for rope Ø mm
00143-5004	Standard	set of 4	4–14mm
00143-5011	Dinghy	set of 2	4–6mm



LIROS GmbH

Sieggrubenstraße 7
D-95180 Berg

Tel. +49 (0) 92 93/80 02-0

www.liros.com · info@liros.com



OFFICIAL SUPPLIER



**DEUTSCHER
SEGLER-
VERBAND**

